

Main Electrical Isolation Switch -
3 Phase (L1, L2, L3) + N + E
5 Wire System, 15 Amp Supply

Air Supply Connection Point -
6 3/4" Connection, 8 Bar (90 psi),
Ø19 I.D. Line (Minimum)

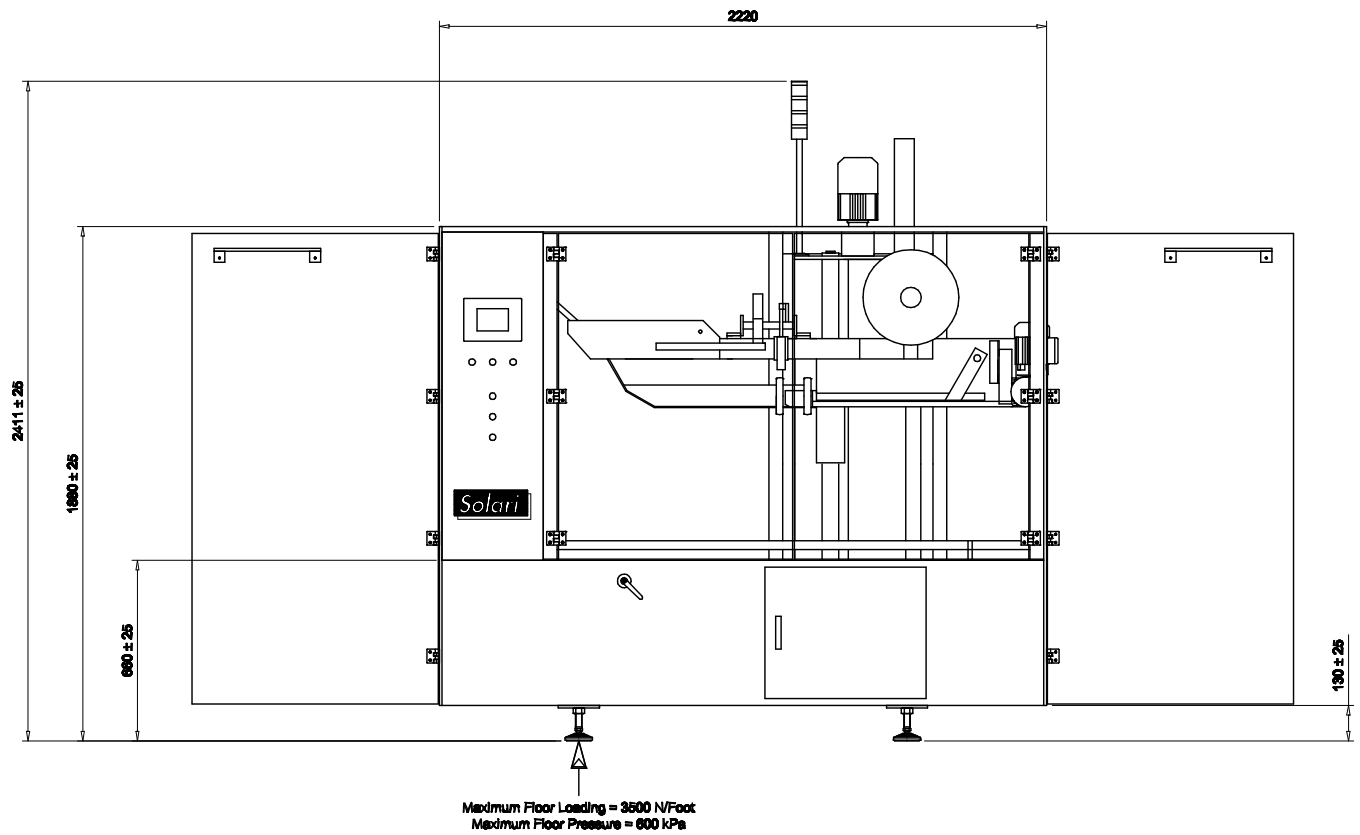
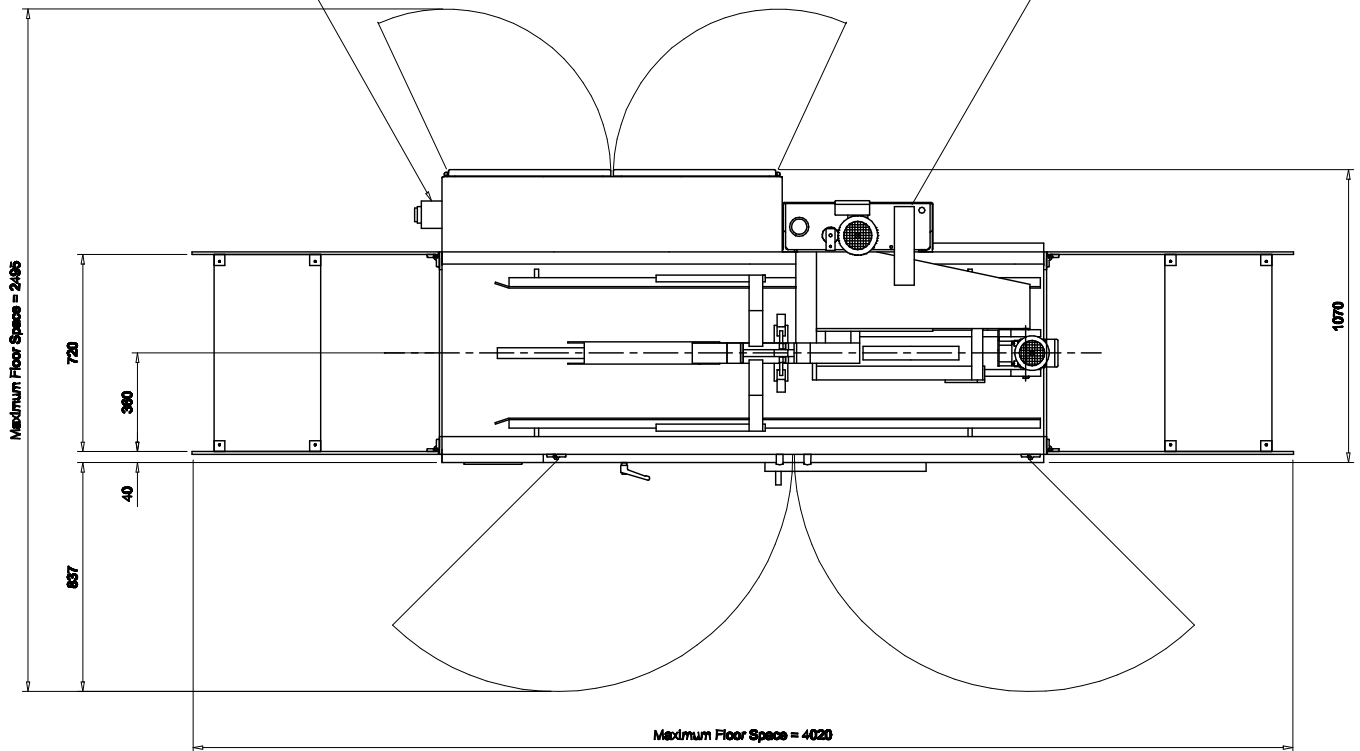

SOLARI PACKAGING SYSTEMS PTY. LIMITED.
7-9 Hoskins Avenue,
BANKSTOWN N.S.W. 2200.
Phone: (02) 9709 8265
Intl: +61 2 9709 8265
Website: www.solari.com.au

P.O. Box 476,
BANKSTOWN N.S.W. 2200
Fax: (02) 9709 5574
Intl: +61 2 9709 5574
Email: solari@solari.com.au

Solari

VA570 Technical Data Sheet

Date: 11.10.04

Drawn: B. Solari

Scale: 1:1

Drawing Number: 570.0.0.0.0

Sheet 1 of 1

File Name: VA570_Technical_Data_Sheet

Serial Number: XX-XX-XX